

ACO GULLY 157 – Bodies for 200mm grates

Part No.
142191

ACO Gully 157, adjustable height body with integrated clamping flange, vertical 110mm outlet, removable foul air trap, grade 316 stainless steel

Product Features

1. **Hygienic design according to ISO 1672 and ISO 14159**
 - Deep drawn body ensures smooth contours eliminating crevices for bacterial growth
 - Rounded internal corners of 3mm and 10mm to enable easy cleaning
 - Drainable design
 - No overlapped welds and no welded corners
2. **Adjustable height tops to suit finished floor level**
3. **Integrated clamping flange for adhesion of rolled waterproof membrane**
4. **Solid edge infill**
 - Solid edge infill improves durability and stability with the surrounding floor, minimising floor cracks
5. **Manufactured from grade 316 stainless steel**
6. **Optional accessories**
 - Removable and fixed strainers for sediment retention
 - Retention chains for strainers and foul air trap
7. **Hydraulic data**
 - Minimum: 3.5 L/s
 - Maximum: 4 L/s

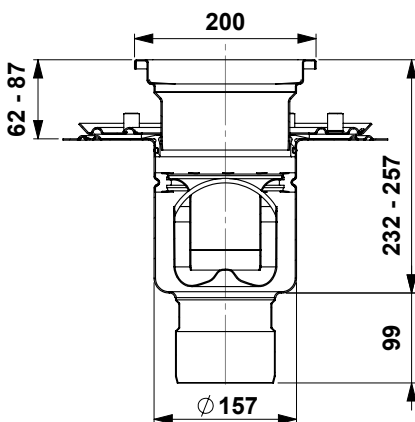

Note: All dimensions are in mm

ACO Specification Information

Specification Clause

The gully shall be ACO Gully 157, adjustable height body with integrated clamping flange, vertical 110mm outlet, removable foul air trap, grade 316 stainless steel (Part No. 142191). Available with optional fixed strainer (Part No. 142001), removable strainer (Part No. 408213) and retention chains.

Materials and Design

The gully shall be manufactured in compliance with ISO 1672 Food processing machinery basic concepts, ISO 14159 Hygiene requirements for the design of machinery and EHEDG:

- The Gully body shall be deep drawn to ensure rounded internal corners no less than 3mm for ease of cleaning;
- The gully shall be designed to ensure complete drainage, with no overlapped welds or welded corners;
- The gully shall come complete with solid edge infill to enhance durability when under load.



General Installation Illustration

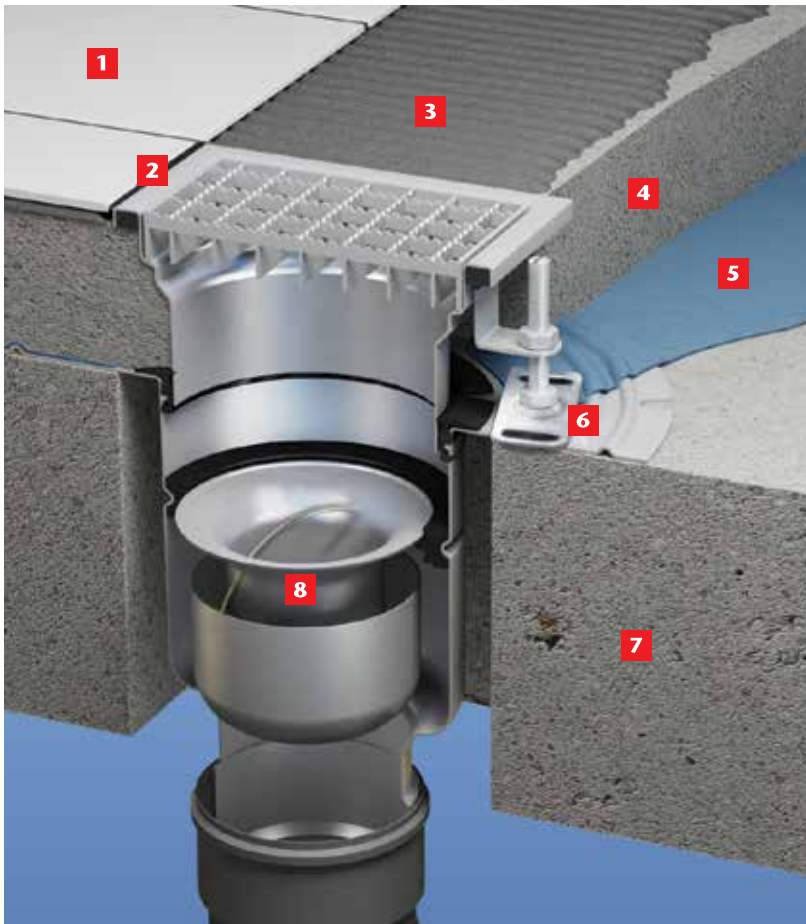

Adjustable height gully with internal FAT in suspended slab with a tile floor finish connecting into stainless pipe.

- 1 Tile
- 2 Flexible sealant
- 3 Cement/tile adhesive
- 4 Screed
- 5 Waterproof membrane (liquid)
- 6 Waterproofing Bonding Flange
- 7 Suspended concrete slab
- 8 Internal FAT

Note: The illustration is shown for guidance only and shows a typical drain and not necessarily the specific type described on the data sheet.

For downloadable drawings, visit www.acowexel.com.au

ACO Polycrete Pty Ltd, Australia

Ph: 1300 765 226
www.acowexel.com.au
sales@acoaus.com.au

ACO Limited, New Zealand

Ph: 0800 448 080
www.acowexel.co.nz
sales@aconz.co.nz

©December, 2014 ACO Polycrete Pty Ltd. All reasonable care has been taken in compiling the information in this document. All recommendations and suggestions on the use of ACO products are made without guarantee since the conditions of use are beyond the control of the company. It is the customer's responsibility to ensure that each product is fit for its intended purpose and that the actual conditions are suitable. ACO Polycrete Pty Ltd. pursues a policy of continuous product development and reserves the right to amend specifications without notice.

