

ACO GULLY 157 – Grates

Part No.
408093

ACO Gully 157 Ladder slip resistant grate, load class M125, grade 304 stainless steel

Product Features

1. Load Class M125 (EN 1253), similar to class C150kN (AS 3996)
2. AS 3996 (Clause 3.3.5) compliant for surface openings in pedestrian areas
3. Slip resistant
4. Manufactured from grade 304 stainless steel
5. Hydraulic data
 - 18,600mm² intake area



Specification Clause

The Ladder slip resistant grate shall be to suit ACO Gully 157 (Part No. 408093). The grate shall be Load Class M125 (EN 1253), similar to Class C150kN (AS 3996).

The grate shall be manufactured from grade 304 stainless steel and compliant with AS 3996 Surface openings in pedestrian areas.

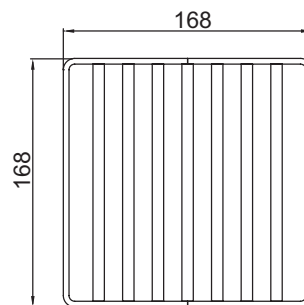

ACO Polycrete Pty Ltd, Australia

Ph: 1300 765 226
www.acowexel.com.au
sales@acoaus.com.au

ACO Limited, New Zealand

Ph: 0800 448 080
www.acowexel.co.nz
sales@aconz.co.nz